

MANUFACTURER MANUAL

MPC6515

V 2.0

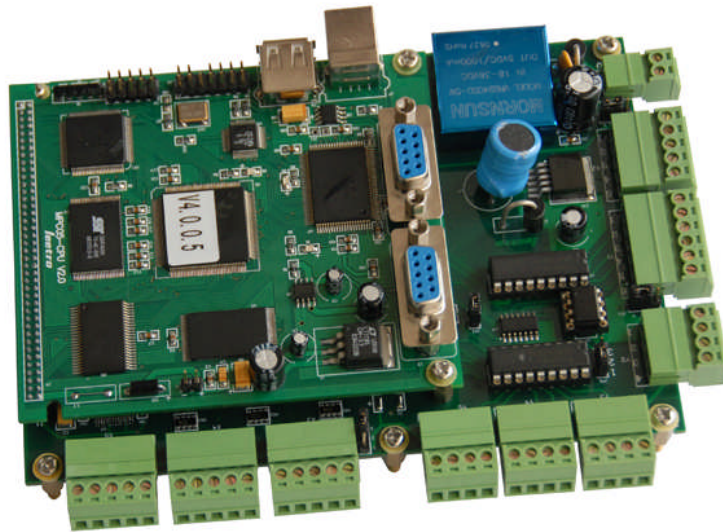

Step-Servo Co., Ltd.
Building 8-B
Dayi Zone of Incubating Hi-Tech
No.1 South 2nd Keyuan Rd
Chengdu 610041
CHINA
www.leetro.com

Copyright

The content of this manual has been carefully prepared and is believed to be accurate, but no responsibility is assumed for inaccuracies.

Step-Servo Co., Ltd. reserves the right to make changes without further notice to any products herein to improve reliability, function or design. Step-Servo Co., Ltd. does not assume any liability arising out of the application or use of any product or circuit described herein; neither does it convey any license under its patent rights of others. Step-Servo and Leetro™ are trademark of Step-Servo Co., Ltd.

Step-Servo Co., Ltd.'s general policy does not recommend the use of its products in life support or aircraft applications wherein a failure or malfunction of the product may directly threaten life or injury. Per Step-Servo Co., Ltd.'s terms and conditions of sales, the user of Step-Servo Co., Ltd. products in life support or aircraft applications assumes all risks of such use and indemnifies Step-Servo Co., Ltd. against all damages.

Table of Content

CHAPTER 1 PREFACE.....	1
CHAPTER 2 OVERVIEW	2
2.1 MPC6515 INTRODUCTION	2
2.2 CONTROL SYSTEM CONFIGURATION	2
2.3 MPC6515 PACK LIST.....	3
CHAPTER 3 INTALLATION.....	4
3.1 MAINBOARD	4
3.2 PAD03	5
CHAPTER 4 MPC6515 HARDWARE INTERFACES.....	6
4.1 MPC6515/CPU INTERFACES	6
4.2 MPC6515/MC V2.0 INTERFACES	8
CHAPTER 5 PAD03 OPERATION.....	11
5.1 CONNECTION	11
5.2 STARTUP MESSAGE	12
5.3 MAIN INTERFACE	12
5.4 SUPPORTING INTERFACE.....	14
5.5 WORK INTERFACE	15
5.6 DOWNLOAD FROM USB STICKER.....	16
CHAPTER 6 HMI DEVELOPMENT	18
6.1 PROTOCOL AND SYSTEM SETTING.....	18
6.2 ADDRESS.....	18
CHAPTER 7 DOWNLOAD DOCUMENT	22
7.1 UPDATE FIRMWARE.....	22
7.2 DOWNLOAD DATA.....	23
CHAPTER 8 ERROR CODE.....	24
8.1 INDICATOR LIGHT DESCRIPTION.....	24
<i>Error Code Description.....</i>	<i>24</i>
CHAPTER 9 FAQ	28
9.1 EXTERNAL INDICATOR LIGHT OF U DISK	28
<i>Functionality.....</i>	<i>28</i>
<i>Instruction.....</i>	<i>28</i>
9.2 CUSTOMIZE PAD03 CONTROL PANEL	28
<i>Functionality.....</i>	<i>28</i>
9.3 EXTERNAL INDICATOR LIGHT OF PROCESSING STATUS.....	29
<i>Functionality.....</i>	<i>29</i>
<i>Instruction.....</i>	<i>29</i>

9.4	BLOW-OFF.....	29
	<i>Functionality</i>	29
	<i>Instruction</i>	29
9.5	GRADE ENGRAVE.....	30
	<i>Functionality</i>	30
	<i>Instruction</i>	30
9.6	SOFTWARE LIMIT UNDER IMMEDIATE MODE.....	30
	<i>Functionality</i>	30
	<i>Instruction</i>	30
9.7	CONTROL TWO LASER HEADS.....	30
	<i>Functionality</i>	30
	<i>Instruction</i>	30

Chapter 1 Preface

Thank you for using Step-Servo's Leetro™ motion controllers. MPC6515, specially designed for laser engraving and cutting system.

This manual will instruct you on using MPC6515 in details.

Please read the instructions carefully before using MPC6515.

	User should debug the system with full consideration on protection measures to avoid any machine damage or human injury
Warning	

	Do not connect or use the Products without understanding this manual.
Prohibited	

	Do not disassemble, modify nor repair the Products without being authorized.
Prohibited	

	Do not subject the Product to water, corrosive or flammable gases, and combustibles.
Prohibited	

Chapter 2 Overview

2.1 MPC6515 Introduction

The MPC6515 controller is a stand-alone control card specially designed for the control system of laser engraving and cutting machines. User can edit graphics, set parameters, and optimize path to develop a process file using computer.

If you want to use DSP5.0 to control the motion, please connect MPC6515 to PC using the USB connect cable in the pack.

2.2 Control System Configuration

Please see the following diagram on MPC6515 motion control system:

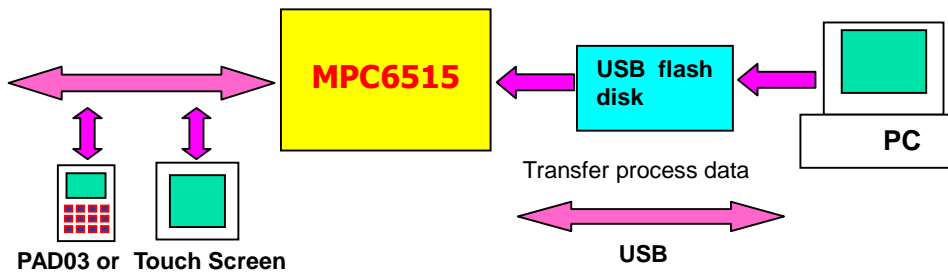

2.3 MPC6515 Pack List

No.	Model	QTY	Description	Type
1	MPC6515	1	Control Board	Standard
2	Udisk	1	Flash momery upgrades firmware and downloads data to MPC6515 (USB sticker cable USB-AA-1.5M is included)	Standard
3	USB-AB-3M	1	Cable connects PC and MPC6515 (Length: 3meters)	Standard
4	C4-PAD03-1.5M	1	Cable connects PAD03-E and MPC6515 (Length: 1.5meters)	Standard
5	PAD03-E	1	Operation Panel, English	Standard
6	Dongle-WHITE	1	Software key (USB interface) in PC to active the installed LaserCut software.	Standard
7	HMI-TPC7062KS	1	7-inch TFT Touch HMI, English, 800x480 Res., 65K Color, CE/FCC	Optional
8	HMI-C9-3M	1	Cable connects MPC6575 and HMI-TPC7062KS (Length: 3meters)	Optional
9	PAD03-TR	1	Operation Panel, Turkish	Optinonal

Chapter 3 Intallation

3.1 Mainboard

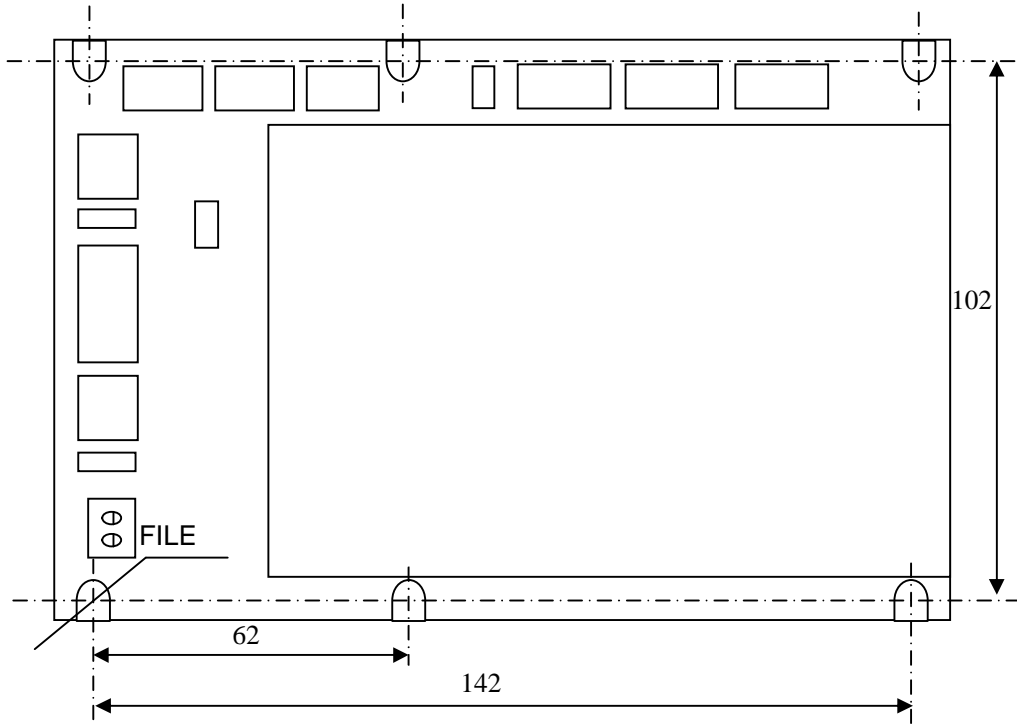

The mainboard adopts six M3 bolts

3.2 PAD03

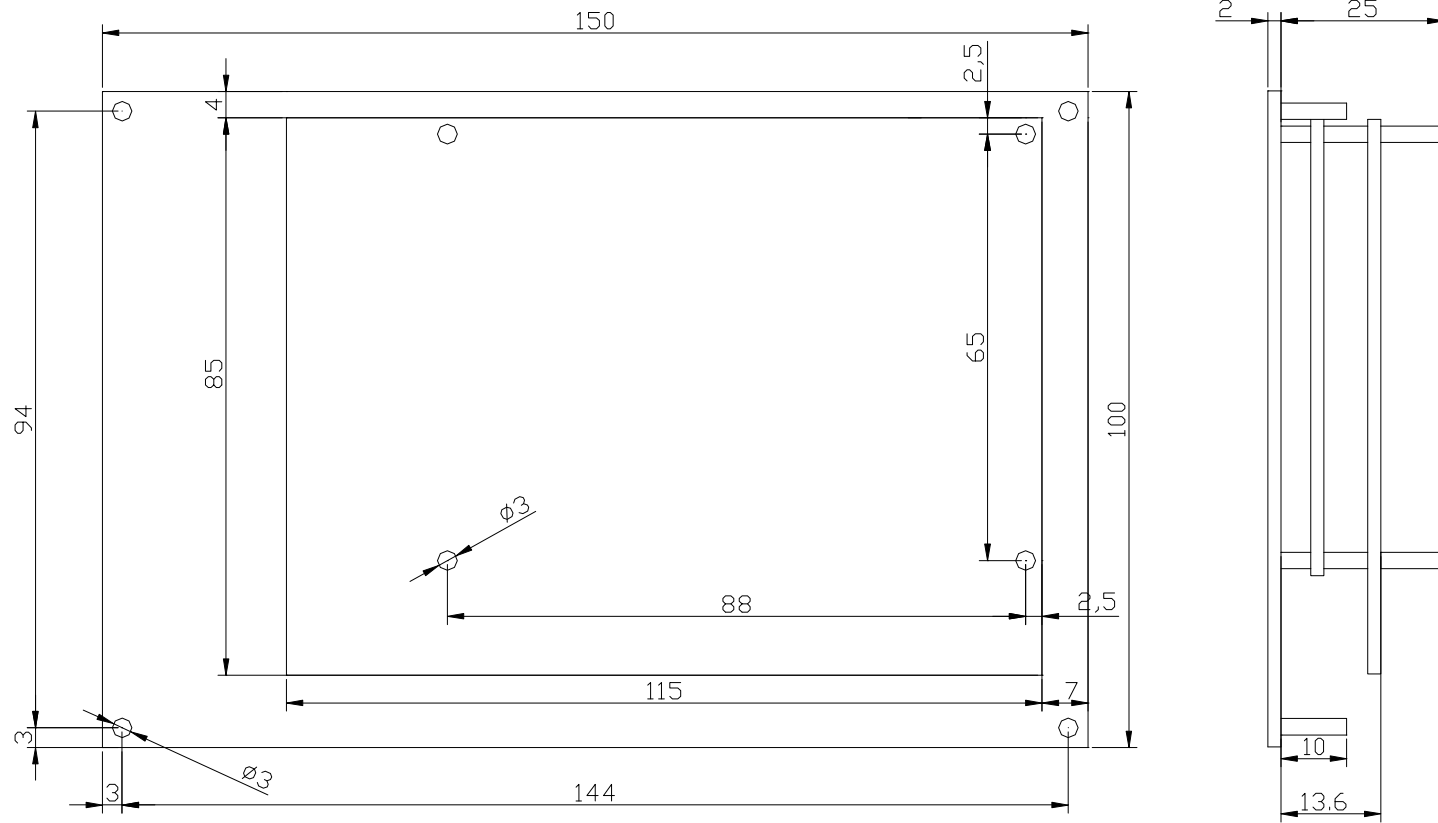

Chapter 4 MPC6515 Hardware Interfaces

MPC6515 controller is composed of two parts:

- 1) MPC6515/MC motion control daughter board
- 2) MPC6515/CPU CPU mainboard

User can find corresponding mark on each board

4.1 MPC6515/CPU Interfaces

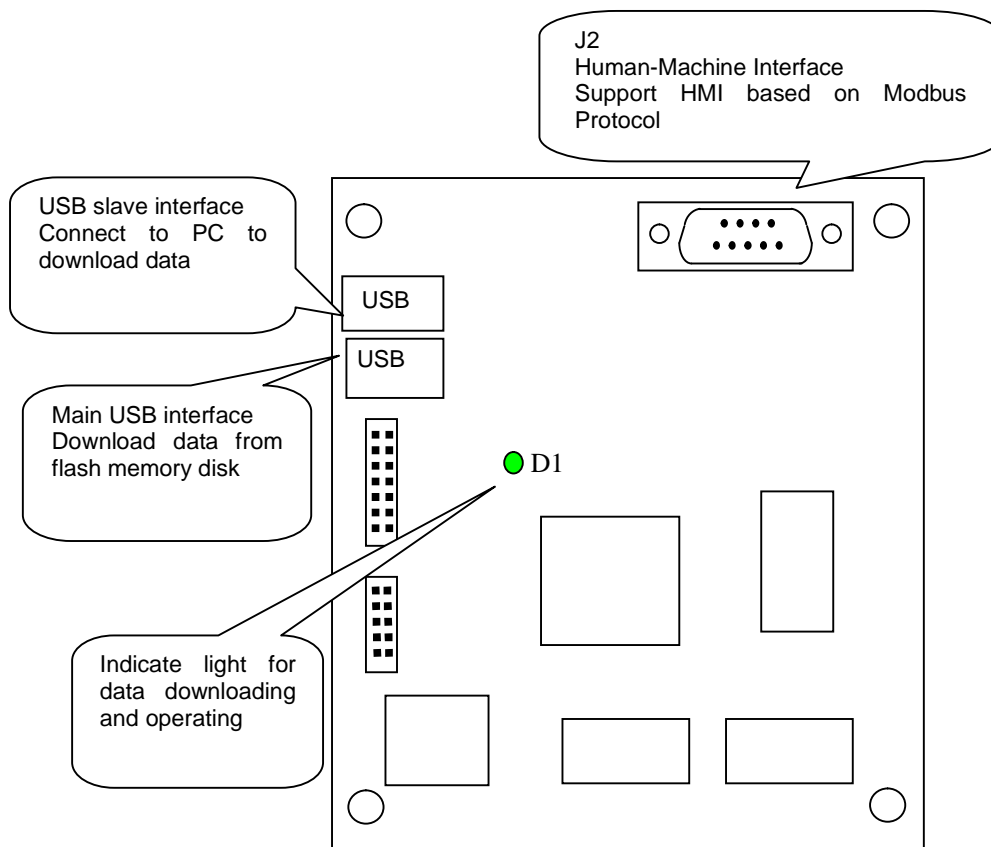

J2: HMI (RS232) -support HMIs such as EasyView, BYDseries HMI, PAD03, etc. based on Modbus Protocol

J2 adopts DB9-pin plug. Pin2, Pin3, Pin5 and Pin9 are used.

Pins	1	2	3	4	5	6	7	8	9
Description		TXD	RXD		GND				+5V

- Wiring of J2 and EasyView RS232 (PLC):

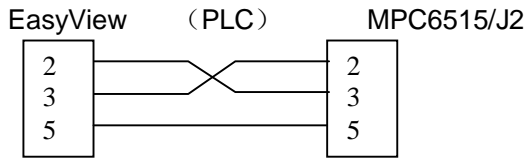

- Wiring of J2 and PAD03 RS232:

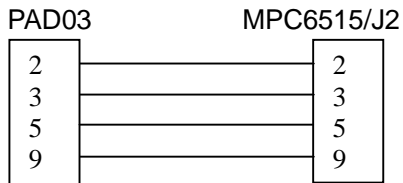

- Wiring of J2 and BYDseries HMI RS232 (PLC):

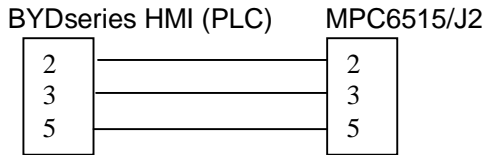

4.2 MPC6515/MC V2.0 Interfaces

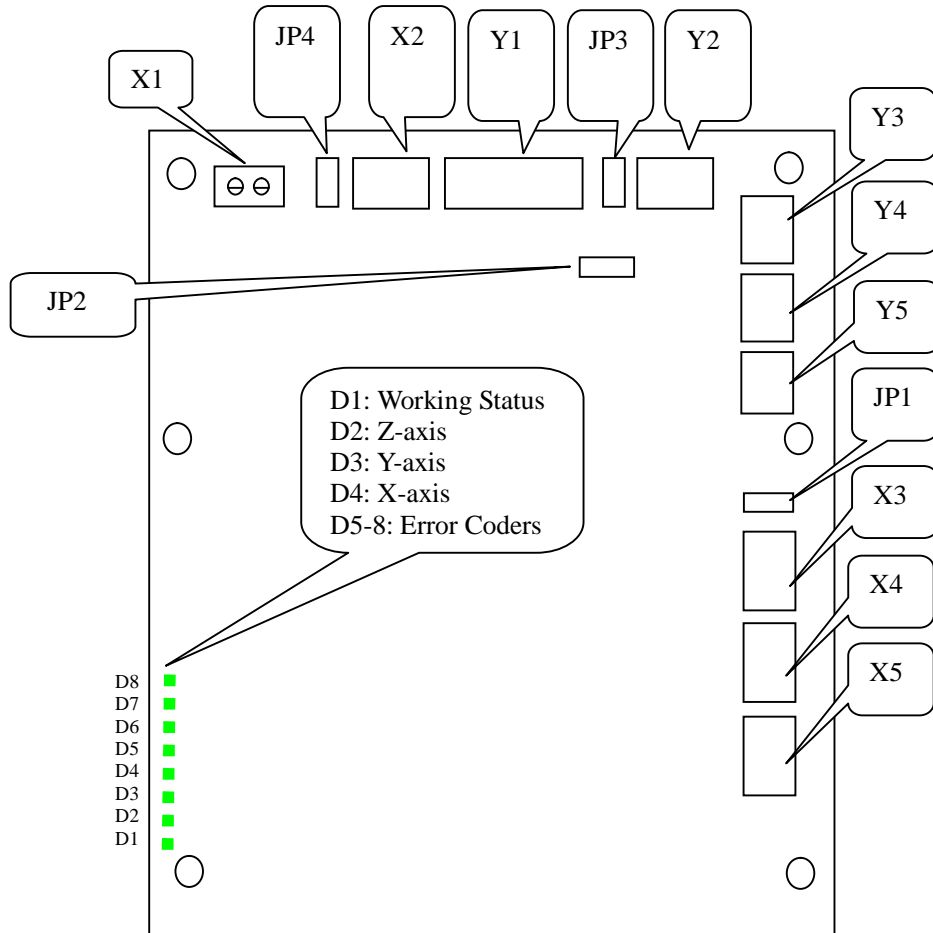



	<p>Please pay attention to the version of MPC6515/MC. If the version of circuit board is V1.0, user cannot find version number in the circuit board.</p>
Caution	

	Pin Array					
	1	2	3	4	5	6
X1	24VDC, 2A	24V GND				
X2	Pedal Switch	Uncapping protection	Reserve	5V/24V GND	5V/24V	
X3	Z-axis Forward Limit	Z-axis Reverse Limit	Z-axis Origin	5V/24V GND	5V/24V	
X4	Y-axis Forward Limit	Y-axis Reverse Limit	Y-axis Origin	5V/24V GND	5V/24V	
X5	X-axis Forward Limit	X-axis Reverse Limit	X-axis Origin	5V/24V GND	5V/24V	
Y1	Blow-off	Processing Finished	USB Flash Disk Indication	Reserve	5V/24V GND	5V/24V
Y2	Laser Power GND	Analog Output	Laser Power	Laser On/Off		
Y3	Z-axis Pulse	Z-axis Direction	5V GND	5V		
Y4	Y-axis Pulse	Y-axis Direction	5V GND	5V		
Y5	X-axis Pulse	X-axis Direction	5V GND	5V		

POWER: Input Power Pin (24VDC)

Note: MPC6515 adopts single 24VDC power supply. The other power pins are output power of the controller.

	MPC6515 adopts single 24VDC. User must use proper and reliable power supply. Exorbitant voltage could result in damage of components, while low voltage could result in problem in operation.
Warning	

	The output power of the above pins should be used only for the common-anode and common-cathode of control signals, and should not be used as the power supply for motor drives. Failure to observe this instruction could result in damage of the controller
Prohibited	

JP1:

Note: JP1 is related with X3, X4 and X5. If 24V voltage is required for input signal ports X3, X4 and X5, the jumper should connect Pin1 and Pin2. If 5V voltage is required, the jumper should connect Pin2 and Pin3. If the jumper is removed, Pin5 of X3, X4 and X5 not connected.

JP2:

Note: JP2 is related with Y2. For analog-control laser power, remove the jumper,connect laser power to Pin2. For PWM-control laser power, connect the power to Pin3.

JP3:

Note: Jumper JP3 can be used for controlling the output 5V/24V from the MPC6515. If the output terminal Y1 is to be used for driving 24V relay, move the jumper to P1-P2. If the output terminal Y1 is to be used for driving 5V relay, move the jumper to P2-P3. When the jumper is removed, P6 of Y1 should be disconnected.

JP4:

Note: JP4 is related with X2. If 24V is required for the general input X2, the jumper should connect Pin1 and Pin2. If 5V voltage is required, the jumper should connect Pin2 and Pin3. If the jumper is removed, Pin5 of X2 not connected.

	Pin 3 and Pin4 of Y3, Y4, and Y5 is output 5V power of MPC6515, can be the common anode for motor drive. Do not connect external 5V to Pin3 and Pin4.
Warning	

	The rated currency of general-purpose output is 100mA. The loaded device should be approved and reliable.
Warning	

	GND of laser power should connect Pin1 of Y2, Common-ground. All inputs and outputs are singl-ended.
Caution	

Chapter 5 PAD03 Operation

5.1 Connection

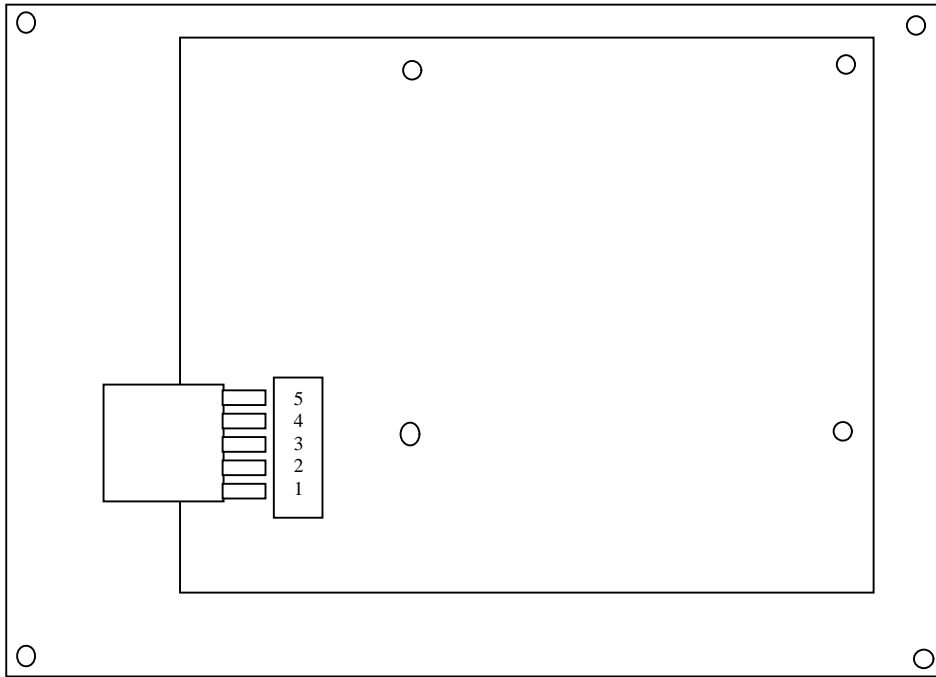

- Connect MPC6515/J2 to PAD03 RS232:

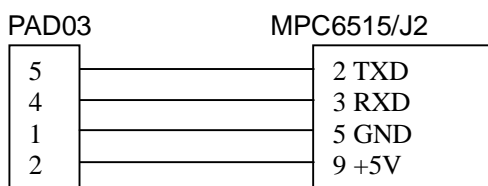

5.2 Startup Message

When the power is on, following message will be displayed (V3.0.10 is the version number of PAD03):

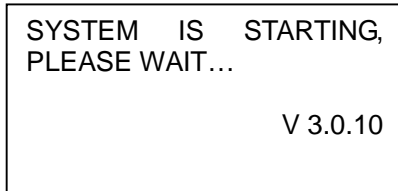

5.3 Main Interface

If there's no communication problem with MPC6515, main interface will be shown as below:





File: The saved file name loaded to MPC6515 controller.



Speed: Percentage of processing speed. When it is 100, the actual speed is the number which is set in processing data.

Power: Percentage of processing power. When it is 100, the actual power is the number which is set in processing data. There are two options such as the **Corner Power** and the **Power**.

Pieces: The value indicates how many pieces of the same work you want.





Del: Delete the file.

Press  or  to select the option you want to edit. Selected option will be highlighted.

Press  or  to set the value of selected option such as the processing speed value, the corner power, the standard power and pieces.

Press  to save the edited settings.



To exit the edit interface, press **Esc** till no option highlighted.

Having completed the settings, user can Press     to move the laser head.

Or press  to enter the edit interface again.

Remark1: Press  to complete the settings on speed, power and pieces.
The completed settings will not be lost even the power is off.

Press **ESC** till cursor disappears to continue the following steps.

To draw lines, hold down **Laser** button, and press    .

Press **Laser** to beam according to the settings of LASER SET.

Press **Datum** to start the homing motion of X-axis and Y-axis simultaneously;

DATUM...

X and Y axes will not stop until they reach the origin point or the user press **Stop** button.

Press **Test** to generate the contouring motion, and following text displays.

BORDERING
PLEASE WAIT

When bordering finished, press  to return to the main interface.

Press **Z** button, text displays as below:

Z-AXIS OPERATE

Press  or  to generate Z-axis jogging.

Press **Datume** to start the homing motion of Z-axis.

Press **Stop** to stop the homing motion of Z-axis.

Press **Z** to return to the main interface.

Text displayed when Z-axis is homing.

Z-AXIS DATUM

Z axis will not stop until it reaches the origin point or the user press **Stop** button.

5.4 Supporting Interface

Press **Menu** to enter the supporting interface as below.

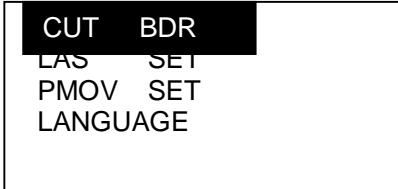

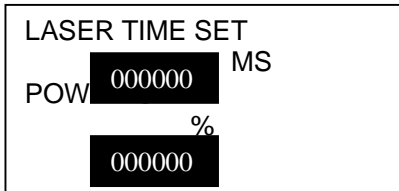

CUT BDR: Laser head will move a rectangle with laser on according to the size of the graphics.

LAS SET: Select this option and press  to enter the LAS SET interface as below.



Press  or  to move the cursor.

Press  or  to modify the number.



Press  to save the settings.

If this value is 0, press **Laser** to switch on the laser; loosen the button to switch off the laser.



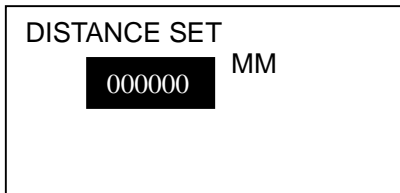

If it's a non-zero value, press **Laser** and laser will shoot a certain time as set by the user.





PMOV SET: Select this option and press  to enter the PMOV SET interface as below.



Press  or  to modify this value.

Press  to save the setting.

If this value is 0, press     to move the laser head, and loosen the button to stop the laser head.

If it's a non-zero value, press     to move the laser head a certain distance as set by the user.

LANGUAGE: Select this option and press  to enter the Language interface as below.

简体中文 繁体中文 ENGLISH

Select the language as you prefer.

5.5 Work interface

Press **Start** to enter the Work interface as below..

FILE	AAA
SPEED	100%
POWER	100 / 100%
TIME	0 : 0 : 15



File: File name.



Speed: Percentage of the processing speed.

Power: Percentage of the processing power.

Time: Elapsed time.

When processing,

Press  and  to adjust the percentage of the processing power (only for Power, not for Corner -Power). Value should be from 0-100.

Press  and  to adjust the percentage of the processing speed. Value should be from 0-100.

Press **Start/Pause** to start or pause the processing.

Press **Stop** to cancel the processing. The user interface shows **Stopped**. Press **Esc** to back to the main user interface.

Press the button **Start/Pause** during the processing to shift between commands such as start and pause.

The pause interface is as below:





PAUSED PRESS START/PAUSE TO CONTINUE
--

When the Pause interface is displayed as the above, only **Start/Pause** and **Stop** buttons are effective.

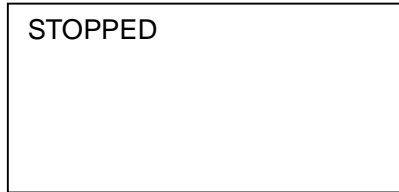
Press the button **Start/Pause** twice to return to the Work interface.





Press **Stop** to cancel the work. User interface displays as below:



When the Stop interface is displayed as the above, only **Start/Pause**, **Esc**, and     buttons are effective.

Press the button **Start/Pause** to enter the Work interface.

If you want to set the parameters, press **Esc** to return to the main interface.

Press     to generate jogging motion according to the completed parameter settings.

When the processing is finished, only **Start/Pause**, and **Esc** buttons are effective.

Press **Start/Pause** to enter the work interface.

Press **Esc** to return to the main interface.

5.6 Download from USB Sticker

Return to the main interface, and plug the USB sticker into the controller. User interface of PAD03 displays as below:

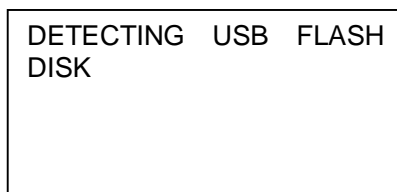

Once the USB sticker is detected without error, the controller starts downloading the processing file from the USB sticker. User interface of PAD03 displays as below:

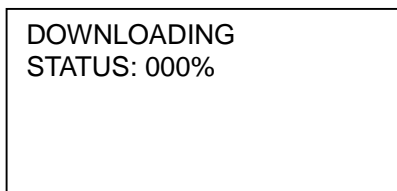

When the download is finished, the buzzer starts ringing. User interface displays as below:



Once the USB sticker is pulled out, the ringing ceases.

	USB flash disk should be formatted to FAT16, if fail to follow this instruction, the flash disk cannot be detected by the controller
Caution	

Chapter 6 HMI Development

All HMIs that support Modbus Protocol can be developed to the control panel of MPC6515, i.e. MT506LV45WV

6.1 Protocol and System Setting

Standard Modbus Protocol

PLC Type: Modbus RTU

Baud rate: 9600bps

Data bit: 8-bit;

Stop bit: 1-bit;

Verify: None.

6.2 Address

- Address and function descriptions of PLC relay shown as below:

Components			Function	Type	Remarks
Address		Properties			
1	0x	ON	Start/Pause	Button	
2	0x	ON/OFF switch	Pause	Button	
3	0x	ON	Resume	Button	
4	0x	ON	Stop	Button	
5	0x	ON/OFF	Up	Button	
6	0x	ON/OFF	Down	Button	
7	0x	ON/OFF	Left	Button	
8	0x	ON/OFF	Right	Button	
9~11	0x		Reserve		
12	0x	ON	Z-axis restoration	Button	
13	0x	ON	XY axes restoration	Button	
14	0x	ON	Speed+1 during processing	Button	
15	0x	ON	Speed-1 during processing	Button	
16	0x	ON	High Speed Power +1 during processing	Button	
17	0x	ON	High Speed Power-1 during processing	Button	
18	0x	ON	Contouring	Button	
19	0x	ON	Cut contour	Button	
20	0x	ON/OFF	Shoot	Button	
21	0x	ON/OFF	Z-axis jogs in positive direction	Button	
22	0x	ON/OFF	Z-axis jogs in negative direction	Button	
30	0x	ON	Delete the file	Button	
31	0x	ON	Go to the next file	Button	
32	0x	ON	Go to the previous file	Button	
33	0x		Status: 1= in processing; 0= process finished	Status	

- Address and function descriptions of PLC register shown as below:

Address	Components	Data Type	Data length		Function	
			bit	byte		
1	4x	BIN	16	1	Percentage of processing speed (%)	
2	4x	BIN	16	1	Laser power corresponding to high speed	
3	4x	BIN	16	1	Laser power corresponding to low speed	
4	4x	BIN	16	1	Set the pieces to be processed	
5	4x	BIN	16	1	Reserve	
6	4x	BIN	16	1	Pieces has been processed	
7	4x	BIN	16	1	Reserve	
8	4x	BIN	32	2	Shooting time:low 16 bit	Shooting time. Unit: mm
9					Shooting time:high 16 bit	
10	4x	BIN	16	1	Jogging distance	
11	4x	BIN	16	1	Reserve	
12	4x	BIN	16	1	Reserve	
13	4x	BIN	16	1	Shooting time	
14	4x	BIN	16	1	Shooting power	
15	4x	BIN	16	1	Pieces of files downloaded to the controller	
16	4x	BIN	16	1	File number	
17	4x		64	4	File name (abcdefgh, 8 bytes shown in text mode)	
21~28	4x	BIN	16	1	Reserve	
29	4x	BIN	16	1	Processing time (h)	
30	4x	BIN	16	1	Processing time (m)	
31	4x	BIN	16	1	Processing time (s)	
32	4x	BIN	16	1	Working status	
33	4x	BIN	16	1	Download progress (with USB flash disk) (%)	

Please see following description on each bit (Address: 32)

F	E	D	C	B	A	9	8
							1: under jogging 0: stop jogging
7	6	5	4	3	2	1	0
1: start downloading 0: download completes	1: plug in USB flash disk 0: remove the USB flash disk	1: back to home 0: stop	1: back to home 0: stop	1: cut contour 0: finished	1: contouring 0: finishied	1: start 0: stop	1: pause 0: resume

0x0002: under processing

0x0003: pause

0x0004: contouring

0x0008: cutting contour

0x0010: XY axes are restored

0x0020: Z axis is restored

0x0040: USB flash disk is detected

0x00c0: downloading data from USB flash disk

0x0080: download successful, remove the USB flash disk

0x0100: under jogging

Each value of the status register corresponding to specific status

Chapter 7 Download Document

For user's convenience, the firmware update file, processing file and configuration file can be downloaded conveniently using USB flash disk.

7.1 Update Firmware

- 1) Copy the updated firmware data (FM.FMW and 05LM201.HDW) to the root directory of USB flash disk (FAT16 format. Recommendation: do not save other files to the flash disk);
- 2) Electricify MPC6515, the indicate light D1 on MPC6515/CPU will flash twice swiftly;
- 3) Plug USB flash disk into MPC6515 within 5 seconds after D1 flashed twice;
- 4) If D1 keeps shining for 2-5 seconds (depending on the size of firmware update file), the firmware is being updated; If there's a indicate light in USB flash disk, user can tell if the data is being read through the indicate light;
- 5) D1 flashed swiftly, firmware is updated successfully; If there's a indicate light in USB flash disk, user can tell if the update is finished through the indicate light;
- 6) After removing the USB flash disk, DSP firmware program will be started.

If MPC6515 fails to work, it's probably that something's wrong during the update process.

Please repeat the above update steps or contact your supplier.

	User should update the firmware only when new version has been released.
Notice	

	To observe the updating process, it's recommended to use a USB flash disk with indicate light.
Notice	

7.2 Download Data

- 1) Copy the files (*.mol) created by engraving&cutting control software to the root directory of USB flash disk (FAT16 format).

Electrify the MPC6515

Plug the USB flash disk into the MPC6515;

If the indicate light D1 on the MPC6515/CPU keeps shining for seconds or minutes (depend on the file size), the controller is downloading processing file.

If D1 flashes swiftly, download completes;

Remove the USB flash disk, select and operate the processing file through the control panel.

	Downloaded configuration file can only be effective after having been selected and operated for the first time. Downloaded processing file can be operated directly.
Notice	

	When you use the MPC6515 at the first time, set up a configuration file according to the machanism parameters. Then download the configuration file to MPC6515 and make it effective. Same operation should be followed each time the narameter changes.
Notice	

	To observe the downloading process, it's recommended to use a USB sticker with indicator light. The user can also lead the external USB indicator light signal to the panel of machine, and use LED to show the working status of the USB sticker (Refer to Chapter 4). Human-machine interface will also display the downloading status.
Notice	

Chapter 8 Error Code

8.1 Indicator Light Description

Working status of MPC6515 is indicated through the 8 LED indicator lights in MC card and 4 indicator lights in CPU card. Please refer to Chapter4 to learn the placement of indicator lights.

Indicator lights in CPU card:

D1: indicate the working status of USB slave interface. It's normally flash green quickly;

D2: indicate the working status of USB slave interface. It's normally flash green slowly;

D3: indicate the operating status. It keeps shining green when processing graphics or downloading data from USB sticker, and stops shining when the processing or downloading is finished.

D4: No use

Indicator lights in MC card:

D1: When MPC6515 is powered on and started, D1 keeps shining;

D2: indicate pulse output status of Z axis. D2 keeps shining when Z axis is outputting pulses, and stops shining when outputting is finished.

D3: indicate pulse output status of Y axis. D3 keeps shining when Y axis is outputting pulses, and stops shining when outputting is finished.

D4: indicate pulse output status of X axis. D4 keeps shining when X axis is outputting pulses, and stops shining when outputting is finished.

D8: When the CPU mainloop of CPU card works normally, D8 flashes.

D7: When data is transmitted between PAD03 and MPC6515, D7 flashes.

Error Code Description

Following Error Code list will direct you to the error causes and solutions.









D1- D8 LEDs indicate an 8-bit status and form 1-byte, i.e.: when D8, D7 and D6 keep shining, while the other indicator lights are off, the corresponding error code is 0xe0; when D1 to D4 are off, D5 to D8 are shining, the corresponding error code is 0xf0.

ON/OFF status indicated by following symbols:

 Indicates the light is shining

 Indicates the light is off

Error codes descriptions are as below:

Error Code	Lights Status	Causes	Solution
0xe0		Mismatched process file (config file) and firmware version. This error is possibly caused by forgetting to re-download the config file after the firmware upgrading.	Replace the function library with the correct one that matches with the firmware version, and re-download the processing file and config file.
0xe1		Mismatched firmware and controller, i.e., MPC05GA firmware is used for MPC6515 by mistake.	Change to correct controller
0xd0		Download data exceeds the rest memory size of MPC6515	Delete the unneeded files in the controller memory, and re-download the processing file.
0xd2		This is a data transmission error possibly occurs in the process of downloading.	Re-download data.
0xd3		This error occurs when there's too much data being transmitted between PAD03 and MPC6515 through the serial port.	1. Restart MPC6515. 2. If the error can't be eliminated by following the 1 st step, replace the PAD03. 3. If the error can't be eliminated by following the 2 nd step, return the controller to the supplier for repair
0xdf		USB interface communication timeout.	1. Replace the USB communication cable if this error occurs frequently. 2. Try on another PC if the error can't be eliminated by the 1 st step 3. Return the controller to the supplier for repair if the error can't be eliminated by the 2 nd step
0xf1		Config file error. This error occurs when the cfg file is incorrect, or the user forgets to download the cfg file.	Re-download correct configuration file
0xf2		Mismatched firmware file (*.fmw) and hardware file (*.hdw)	Re-download correct fmw file and hdw file.

	Please restart MPC6515 if any error occurs to resume to the default status. Refer to the above error codes descriptions to correct the error.
Caution	

Chapter 9 FAQ

9.1 External Indicator Light of U Disk

Functionality

User can't see the indicator lights on MPC6515 installed inside a machine. During the process of data downloading, user can observe the downloading process through the interface of PAD03, or through an external connected indicator light of the USB flash disk. The external indicator light is used to lead the reading status signal of USB flash disk to the machine panel, and show the status with LED.

Instruction

Use Pin3 of Y1 on MPC6515/MC(Indicate light signal of USB flash disk) to drive the relay or LBD.

9.2 Customize PAD03 Control Panel

Functionality

PAD03 is composed of control panel, liquid crystal display and main board. If you want to customize the panel, please refer to the following interface description graph.

The control panel is connected to the main board through a 9pin header.

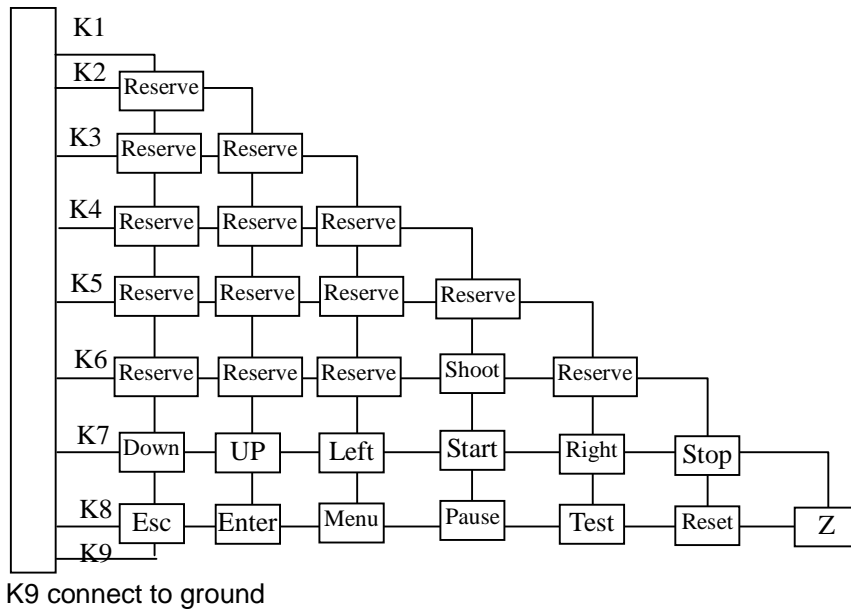

User can design the panel according to the above diagram.

9.3 External Indicator Light of Processing Status

Functionality

To confirm the processing status before operating the system, an external indicator light could be connected to show the processing status. The external indicator light can be used to lead the processing status signals to the machine panel, and show the status with LBD or drive other indicator lights through circuit.

Instruction

Use Pin2 of Y1 on MPC6515/MC (light signal indicating process completion) to drive the relay or LBD.

9.4 Blow-off

Functionality

Blow-off switch can be controlled through I/O interface to blow off the heat and ash produced during the laser engraving and cutting.

Instruction

Pin1 of Y1 can be used as the I/O interface controlling blow-off. User can control the

status of Pin1 using processing commands. When the interface is low level, blow-off is on. When the interface is high level, blow-off is off.

9.5 Grade Engrave

Functionality

In accordance with the functionality of PCI-bus controller MPC03L*.

Instruction

The version of MPC6515 is required to be V4.1.0.0 or above. Version of software should be V2007.3.3 or above. Set the process mode as Grade Engrave on the software. MPC6515 V4.1.0.0 supports PWM grade engrave, and 1-ch analog grade engrave.

9.6 Software Limit under Immediate Mode

Functionality

This functionality is effective only on the premise that the machine has been to the origin point. Machine will auto-detect if the process exceed worktable before output.

Instruction

Upgrade the version of MPC6515 to V4.1.0.0 or above.

9.7 Control Two Laser Heads

Functionality

Control power of two laser heads independently.

Instruction

Upgrade MPC6515 to V4.1.0.0 or above. Upgrade software to V2007.3.3 or above. Set power mode to "LaserPowerMode=4", and set the distance of two laser heads.